



N-Channel Enhancement Mode Field Effect Transistor

PRODUCT SUMMARY

| V _{DSS} | I _D | R _{DS(ON)} (mΩ) MAX |
|------------------|----------------|------------------------------|
| 30V | 7A | 30 @ V _{GS} = 10V |
| | | 50 @ V _{GS} = 4.5V |

FEATURES

- Super high dense cell design for low R_{DS(ON)}.
- Rugged and reliable.
- Surface Mount Package.

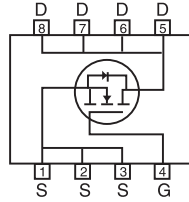
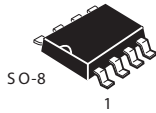
ABSOLUTE MAXIMUM RATINGS (T_A=25 °C unless otherwise noted)

| Parameter | Symbol | Limit | Unit |
|--|-----------------------------------|------------|------|
| Drain-Source Voltage | V _{DS} | 30 | V |
| Gate-Source Voltage | V _{GS} | ±20 | V |
| Drain Current-Continuous ^a @ T _J =125 °C -Pulsed ^b (300ms Pulse Width) | I _D | 7 | A |
| | I _{DM} | 28 | A |
| Drain-Source Diode Forward Current ^a | I _S | 2.8 | A |
| Maximum Power Dissipation ^a | P _D | 2.5 | W |
| Operating Junction and Storage Temperature Range | T _J , T _{STG} | -55 to 150 | °C |

THERMAL CHARACTERISTICS

| | | | |
|--|------------------|----|------|
| Thermal Resistance, Junction-to-Ambient ^a | R _{θJA} | 50 | °C/W |
|--|------------------|----|------|

S DM9410

ELECTRICAL CHARACTERISTICS (T_A=25 °C unless otherwise noted)

| Parameter | Symbol | Condition | Min | Typ ^c | Max | Unit |
|--|---------------------|---|-----|------------------|------|-------|
| OFF CHARACTERISTICS | | | | | | |
| Drain-Source Breakdown Voltage | BV _{DSS} | V _{GS} =0V, I _D =250uA | 30 | | | V |
| Zero Gate Voltage Drain Current | I _{DSS} | V _{DS} =24V, V _{GS} =0V | | | 1 | uA |
| Gate-Body Leakage | I _{GSS} | V _{GS} = ±20V, V _{DS} =0V | | | ±100 | nA |
| ON CHARACTERISTICS^b | | | | | | |
| Gate Threshold Voltage | V _{GS(th)} | V _{DS} =V _{GS} , I _D =250uA | 1 | 1.8 | 3 | V |
| Drain-Source On-State Resistance | R _{DS(ON)} | V _{GS} =10V, I _D =7A | | | 30 | m ohm |
| | | V _{GS} =4.5V, I _D =3.5A | | | 50 | m ohm |
| On-State Drain Current | I _{D(ON)} | V _{DS} =5V, V _{GS} =10V | 30 | | | A |
| Forward Transconductance | g _{FS} | V _{DS} =5V, I _D =7A | | 12 | | S |
| DYNAMIC CHARACTERISTICS^c | | | | | | |
| Input Capacitance | C _{ISS} | V _{DS} =15V, V _{GS} =0V f=1.0MHz | | 510 | | pF |
| Output Capacitance | C _{OSS} | | | 235 | | pF |
| Reverse Transfer Capacitance | C _{RSS} | | | 56 | | pF |
| SWITCHING CHARACTERISTICS^c | | | | | | |
| Turn-On Delay Time | t _{D(ON)} | V _{DD} =15V, I _D =1A, V _{GS} =10V, R _{GEN} =10 ohm | | 21 | 40 | ns |
| Rise Time | t _r | | | 20 | 40 | ns |
| Turn-Off Delay Time | t _{D(OFF)} | | | 27 | 55 | ns |
| Fall Time | t _f | | | 115 | 230 | ns |
| Total Gate Charge | Q _g | V _{DS} =15V, I _D =1A, V _{GS} =10V | | 13 | 20 | nC |
| | | V _{DS} =15V, I _D =1A, V _{GS} =4.5V | | 6.5 | 10 | nC |
| Gate-Source Charge | Q _{gs} | V _{DS} =15V, I _D =1A, V _{GS} =10V | | 2 | | nC |
| Gate-Drain Charge | Q _{gd} | | | 2.3 | | nC |

SDM9410

ELECTRICAL CHARACTERISTICS ($T_A=25^\circ\text{C}$ unless otherwise noted)

| Parameter | Symbol | Condition | Min | Typ ^c | Max | Unit |
|---|----------|---------------------------|-----|------------------|-----|------|
| DRAIN-SOURCE DIODE CHARACTERISTICS^b | | | | | | |
| Diode Forward Voltage | V_{SD} | $V_{GS} = 0V, I_s = 5.3A$ | | 0.76 | 1.1 | V |

Notes

- a. Surface Mounted on FR4 Board, $t \leq 10\text{sec}$.
- b. Pulse Test: Pulse Width $\leq 300\mu\text{s}$, Duty Cycle $\leq 2\%$.
- c. Guaranteed by design, not subject to production testing.

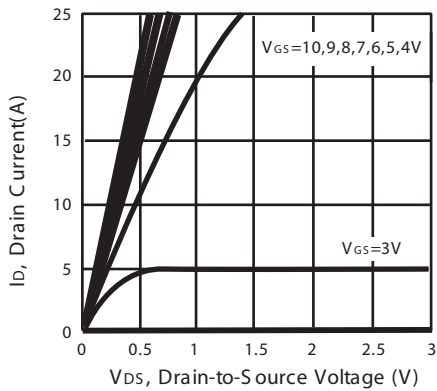

Figure 1. Output Characteristics

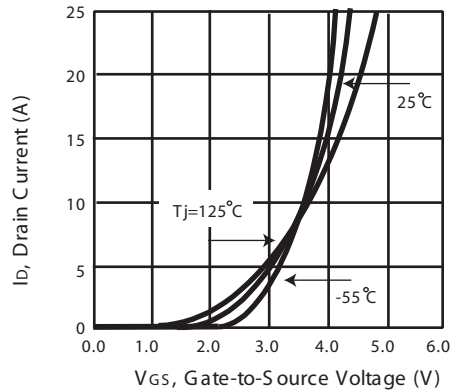

Figure 2. Transfer Characteristics

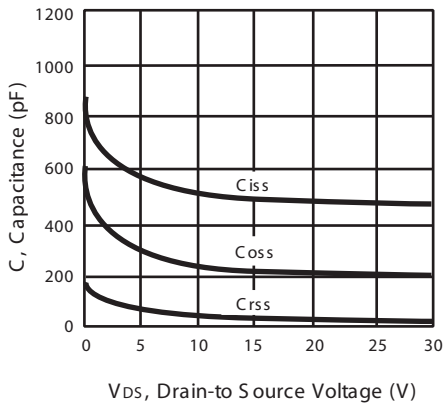

Figure 3. Capacitance

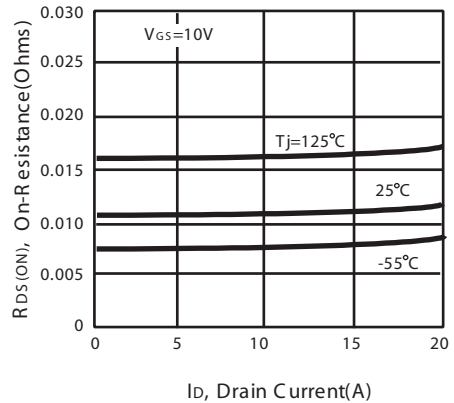

Figure 4. On-R Resistance Variation with Drain Current and Temperature

S DM9410

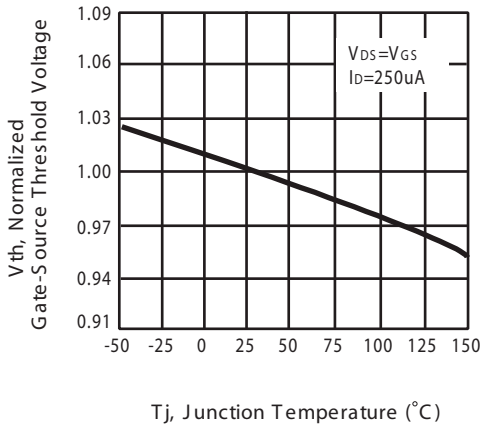

Figure 5. Gate Threshold Variation with Temperature

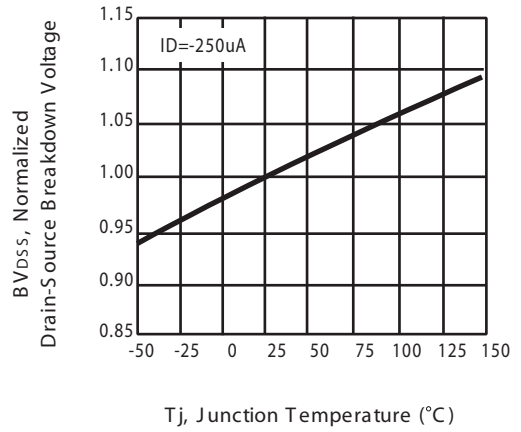

Figure 6. Breakdown Voltage Variation with Temperature

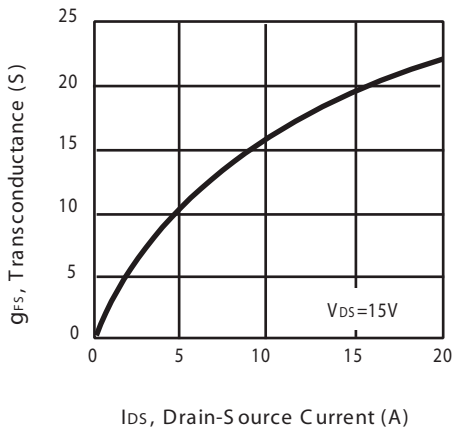

Figure 7. Transconductance Variation with Drain Current

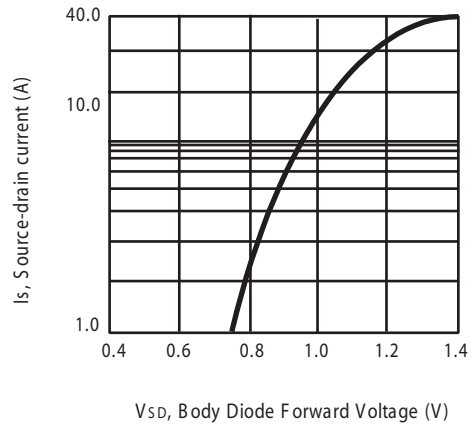

Figure 8. Body Diode Forward Voltage Variation with Source Current

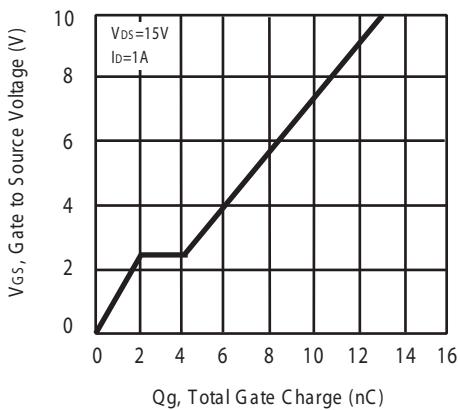

Figure 9. Gate Charge

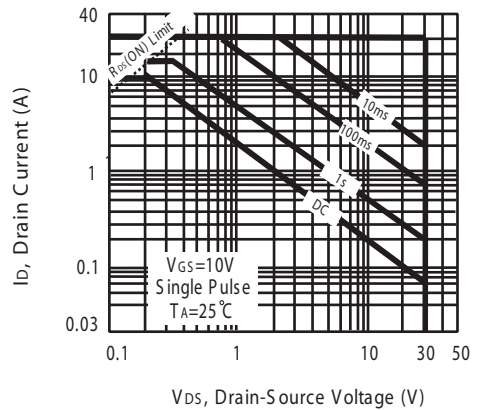

Figure 10. Maximum Safe Operating Area

SDM9410

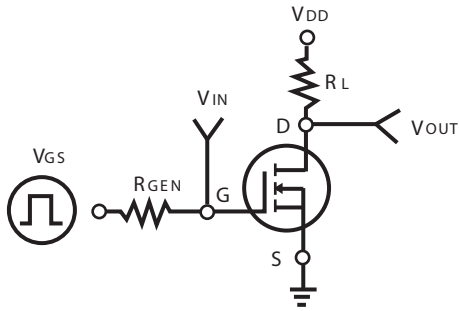

Figure 11. Switching Test Circuit

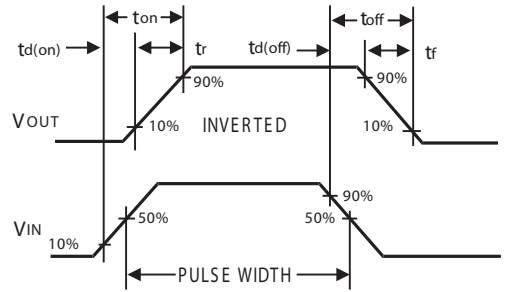

Figure 12. Switching Waveforms

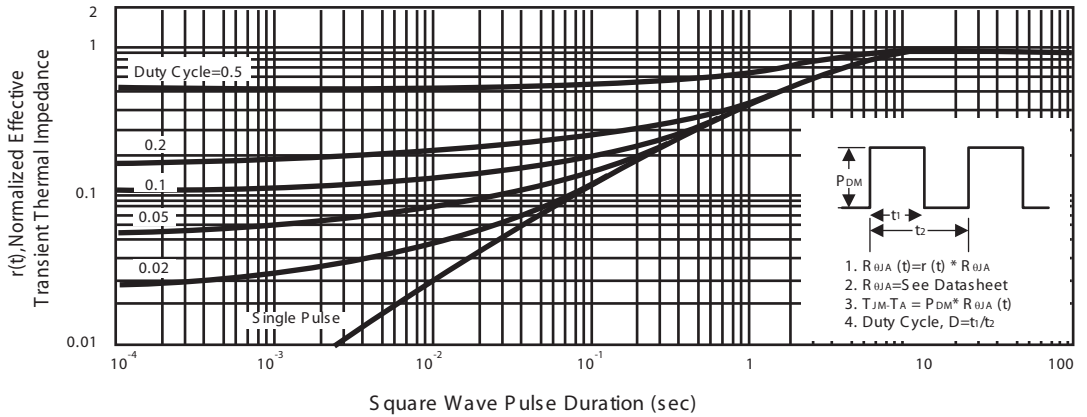

Figure 13. Normalized Thermal Transient Impedance Curve